

(No Model.)

O. E. DUNHAM.

Method of Making Blades for Heel Shaves.

No. 241,322.

Patented May 10, 1881.

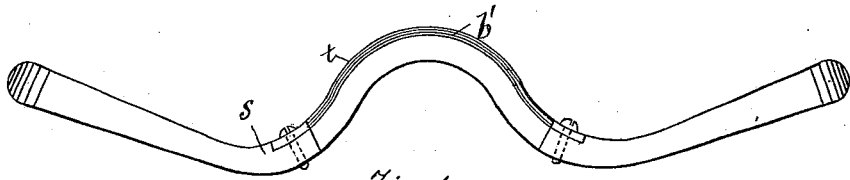

Fig. 1.

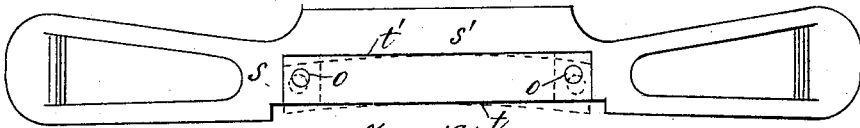

Fig. 1a

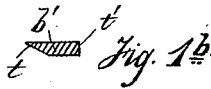

Fig. 1b

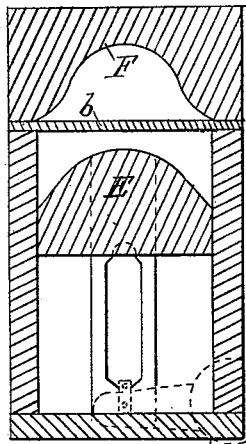

Fig. 2

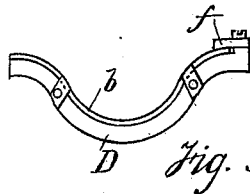

Fig. 3.

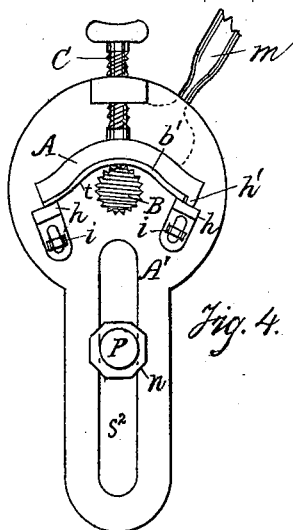

Fig. 4.

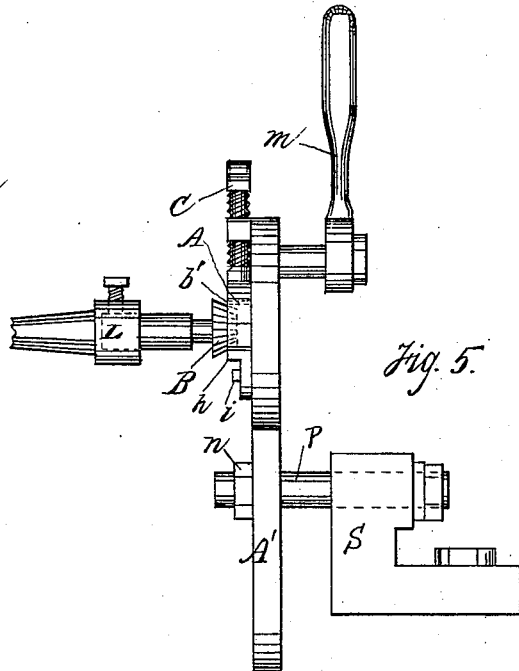

Fig. 5.

Witnesses:
H. G. Wadlin.
W. C. Linco

Inventor:
O. E. Dunham
by Wright & Bond Atty.

UNITED STATES PATENT OFFICE.

OSCAR E. DUNHAM, OF BROCKTON, MASSACHUSETTS.

METHOD OF MAKING BLADES FOR HEEL-SHAVES.

SPECIFICATION forming part of Letters Patent No. 241,322, dated May 10, 1881.

Application filed January 27, 1881. (No model.)

To all whom it may concern:

Be it known that I, OSCAR E. DUNHAM, of Brockton, in the county of Plymouth and State of Massachusetts, have invented certain Improvements in the Method of Making Blades for Heel-Shaves, of which the following is a specification.

This invention relates to blades for heel-shaves for shaving the heels of boots and shoes, such as described in Letters Patent of the United States No. 223,583, issued to me on the 13th day of January, 1880; and this invention consists, first, in an improved process for forming and completing said blades after the blank has been formed from the metal; and the invention consists, secondly, in apparatus for sharpening the curved blades, all of which I will now proceed to specifically describe, reference being had to the accompanying drawings, forming part of this specification, in which—

Figure 1 and Fig. 1^a represent, respectively, side and top views of a heel-shave cutter with blade attached. Fig. 1^b represents a transverse section of blade. Figs. 2 and 3 represent apparatus for curving the blades during the process of manufacture embodying my invention. Figs. 4 and 5 represent apparatus for sharpening the curved blades, also embodying my invention, Fig. 4 being a front view, and Fig. 5 a side view, of said apparatus.

In these several figures similar letters of reference indicate the same parts.

In the drawings *b'*, represents a blade attached to the stock *s* of a heel-shave. In the ordinary process of forming these blades the cutting-edge *t* of the blade is beveled prior to bending the blank to the curvature required in the completed blade. When this is done and the blank is afterward subjected to the bending process, it is found to be impossible to prevent the back *t'* of the blade from assuming a slight lateral curvature, (shown by the dotted lines, Fig. 1;) and this curvature of the back prevents the blade from bearing equally against the shoulder *s'* of the stock throughout its entire length, and it also throws the extremities of the blade *b'* outwardly, so that the orifices *o o* in said blade, whereby the blade is attached to the stock, do not coincide with the corresponding orifices in the stock. It is therefore necessary, when the blade is formed

in this manner, to file away a portion of the back *t'* of the blade until the said back will bear equally against the shoulder of the stock throughout its length, and the requisite coincidence is secured between the orifices in the blade and those in the stock. It is also customary in forming the blades to heat the blank, in order to more readily bend it to the curvature desired in the completed blade. In this heating process there is great danger of destroying the temper of the steel of which the blank is composed, and blades are frequently rendered worthless by overheating. Both of these disadvantages accompanying the ordinary method of forming and completing the blades are overcome by my improved process, in which the blanks are bent without being heated and the cutting-edge beveled after the blank has been bent to the desired curvature. In this operation I take a blank, rectangular in form, stripped from a sheet of steel of the requisite quality, and subject the same to the action of the bending-machine shown in Fig. 2, said figure representing a vertical section of said machine. This machine consists of a former, *F*, having its under surface curved in a manner corresponding to the desired curvature of the blade. Beneath this former is a follower, *E*, adapted to be forced upwardly against the former *F* by suitable mechanism.

In the operation the blank *b* is interposed between the former *F* and the follower *E*, and the latter, being forced upwardly, presses the blank against the former *F*, and so causes it to assume a curvature corresponding to the curvature of the former. The blank *b*, when curved in this manner without being heated, is found to lack the precise curvature required, owing to the elasticity of the steel from which it is formed. I therefore next confine the bent blank in a concave die, *D*, a side elevation of which is shown in Fig. 3. The concavity of the die *D*, like the under side of the former *F*, is curved to correspond with the required curvature of the blade. The blank *b* being confined within the die by means of the adjustable clamps *f*, it is then subjected to the percussion of a hammer, this operation serving to "set" the steel and to give the blank the exact curvature desired in the completed blade.

In order to produce the cutting-edge and

thus complete the blade, I make use of the apparatus shown in Figs. 4 and 5.

In these figures, A represents a steel former resting upon shoulders *h h* upon the plate A', and maintained in position upon said shoulders by the adjustable clamp C. The plate A' is pivoted to the lathe-stock S by means of the pivot or shaft P passing through a slot, *s*², in the said plate, and said plate is adjustable vertically upon the pivot P by means of the nut *n*. The former A is curved to correspond to the curvature of the blade *b'*, and when said blade is to be operated upon it is rigidly confined between the former A and the shoulders *h h*, being protected against longitudinal displacement by the shoulder *h'* on the former A. The shoulders *h h* are adjustable by means of the nuts *i i*.

B represents a burr adapted to be attached to the spindle or shaft L of a lathe in the manner in which an ordinary bit is similarly attached, and arranged to act upon the edge *t* of the blade *b'* when the lathe is operated. The plate A' being partially rotated upon its pivot P, the burr B is brought to bear upon the edge *t* of the blade *b'* throughout the required portion of its length, or to within one-half inch of each extremity, the remaining half-inch being left intact to rest upon the shoulders of the heel-shave stock S when the blade is confined in said stock. The cutting-edge of the blade *b'* being thus partially formed, it is afterward tempered and ground, after which it only remains to form the orifices *o o* in the extremities of said blade, whereby it is attached to the stock S, and I form these orifices by subjecting the blades to the action of an ordinary drilling-jig.

The entire operation of forming the blades by my improved process may be concisely described as follows: The blanks are first bent by means of the machine shown in Fig. 2, by the action of which machine they are made to assume nearly the curvature desired. The curving of the blanks is completed and the precise curvature imparted to the blades by hammering them while confined within the concave die shown in Fig. 3. The blades are next confined upon the former A, (shown in Figs. 4 and 5,) and by the rotation of the lathe-spindle the burr B is brought to bear upon the edge *t* of the blade, thus producing the cutting-edges, as previously described. In this latter operation the burr B is made to revolve toward the operator, and the former-plate A' is gradually rotated from the operator upon its pivot P by means of the handle *m*. The orifices *o o* are finally drilled in the extremities of the blades *b'*, thus completing them. By thus bending the blanks without heating them and forming the cutting-edges after the blanks have been

made to assume the proper curvature, I entirely avoid all danger of injury to the blanks by overheating or from distortion of the back side of the blade in bending. It is thus possible to make any number of blades and of any desired curvature, and insure a perfect coincidence between the orifices in the blades and the corresponding orifices in the heel-shave stock without any alteration or fitting of the blades subsequent to the operation of forming the same, as herein described.

The shoulders *h h*, the plate A', and the former A, Fig. 4, being severally adjustable, the apparatus is adapted to receive blades of any desired curvature for the purpose of forming the cutting-edges.

Having thus described my invention, what I claim, and desire to secure by Letters Patent, is—

1. That improvement in the art of making sharpened curved heel-shave blades from rectangular sheet-steel blanks which consists in, first, bending the blank to the desired curvature, and, secondly, sharpening the same after it is bent, the specified order of performing said operations enabling the blank to be bent without distortion of its back, substantially as described.

2. That improvement in the art of bending steel blanks for heel-shave blades, the same consisting in, first, bending the blank in a cold condition between dies, and, secondly, hammering the bent blank against a concave die to set it and give it the exact curvature of the die, substantially as described.

3. The improved method herein described of making cutters for heel-shaves from rectangular sheet-steel blanks, the same consisting in, first, bending the blank in a cold condition by suitable dies; secondly, hammering the bent blank against a concave die; and, thirdly, sharpening the blank after it is bent, substantially as described.

4. The described apparatus for sharpening curved blanks, the same consisting of a curved former, A, attached to an adjustable plate, A', pivoted to a lathe-stock and adapted to hold the blank, and a rotary burr, B, held in position to bevel one edge of the blank, the plate A' being turned on its pivot to present different parts of the edge of the blank to the burr, as set forth.

In testimony whereof I have signed my name to this specification, in the presence of two subscribing witnesses, this 20th day of January, A. D. 1881.

OSCAR E. DUNHAM.

Witnesses:

A. P. HAZARD,
ETHAN ALLEN.